

Description	Value
General information:	
Product name:	PM 1
Product No:	96848701
EAN number:	5700311918210
Technical:	
Approvals:	CE,EAC,RCM
Approvals for drinking water:	WRAS,ACS
Return valve:	YES
Adjustable start pressure (Yes/No):	N
Start pressure:	2.2 bar
Materials:	
Pump housing:	Composite
Pump housing:	Polypropylene
Installation:	
Maximum ambient temperature:	50 °C
Inlet connect:	G1"
Outlet connect:	G1"
Inlet thread:	EXTERNAL
Outlet thread:	EXTERNAL
Liquid:	
Liquid temperature range:	0 .. 40 °C
Electrical data:	
P1 max.:	1200 W
Mains frequency:	50 / 60 Hz
Suitable for 50/60 Hz:	Yes
Rated voltage:	1 x 220-240 V
Maximum current consumption:	10 A
Enclosure class (IEC 34-5):	IP65
Power plug:	No plug
Controls:	
Type of connector:	No plug
Dry running protection:	YES
Tank:	
Tank volume:	0.1 l
Others:	
Net weight:	0.89 kg
Gross weight:	1.65 kg
Shipping volume:	0.008 m ³
Environmental approvals:	WEEE

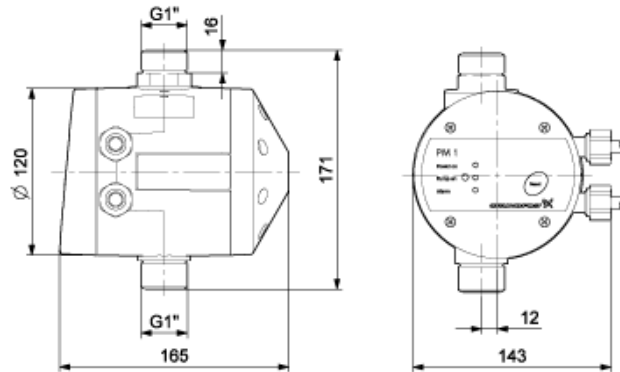

96848701 PM 1

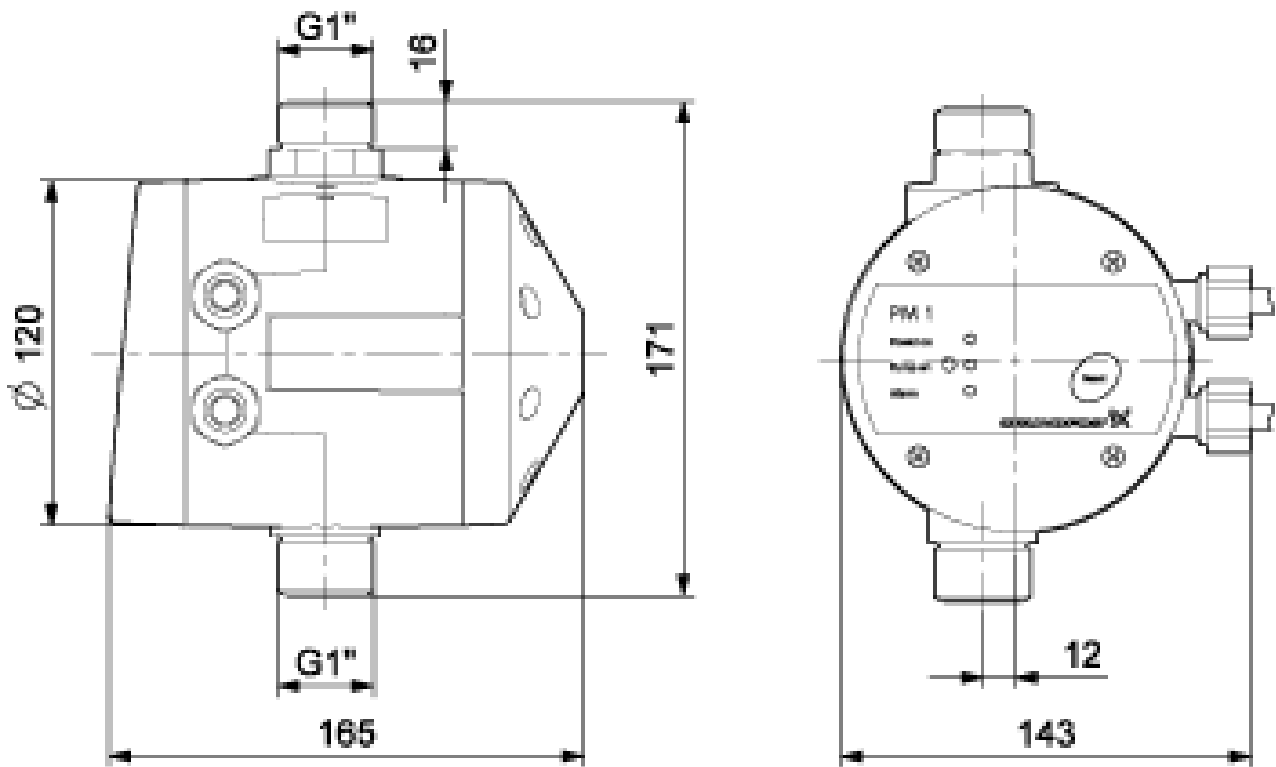

Note! All units are in [mm] unless others are stated.
Disclaimer: This simplified dimensional drawing does not show all details.